

Solutions for
**METAL
WORKING**

 **Bonfiglioli**

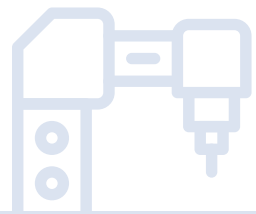

Solutions for

CONTENTS

METAL CUTTING, BENDING, PUNCHING & MACHINE TOOLS	6
Laser tube cutting	8
Metal sheet	9
Metal sheet bending.....	10
METAL FORMING & SHAPING MACHINERY.....	12
Plate roll, plate bending.....	14
Metal profile bending	15
Flanging machines.....	16
Wire drawing machine.....	18
Pulling capstan	20
Self-Aligning roller beds	22
HOT METAL.....	24
Furnace	26
Roller Table	28
Ladle Transfer Car	30
COMPLETE SOLUTIONS FOR POWER TRANSMISSION & AUTOMATION	32
OUR GLOBAL PRESENCE.....	34

Engineering Solutions



WWW.BONFIGLIOLI.COM

METAL WORKING

Bonfiglioli is a longstanding leading manufacturer of mechatronic solutions for the metal working industry, supplying excellence and innovation by keeping focus on our customers and their needs.

Thanks to our know-how and long-term co-design with key players in this industry, we supply dedicated solutions thanks to our wide product portfolio and integration capabilities, combining both industrial and precision gearboxes with motors and servomotors up to IE5, as well as with frequency inverters.

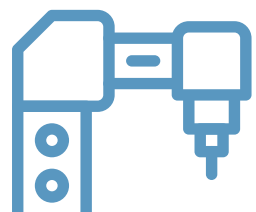

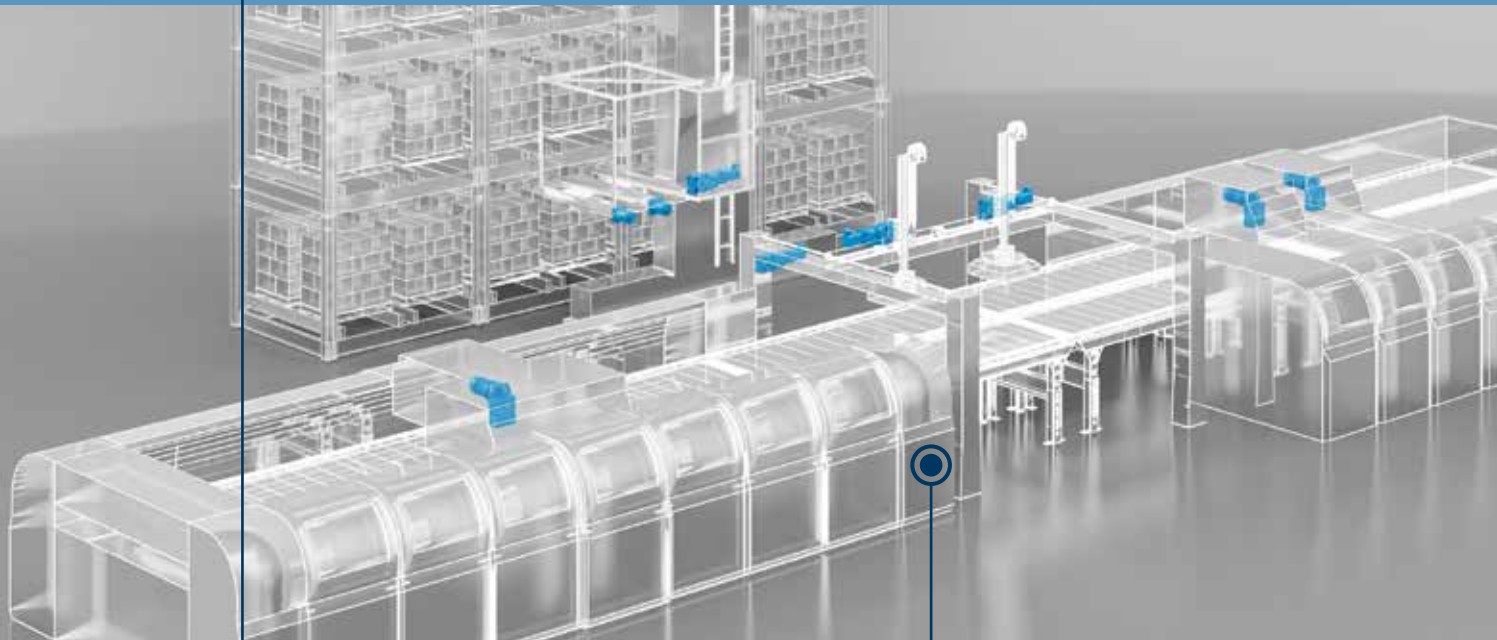
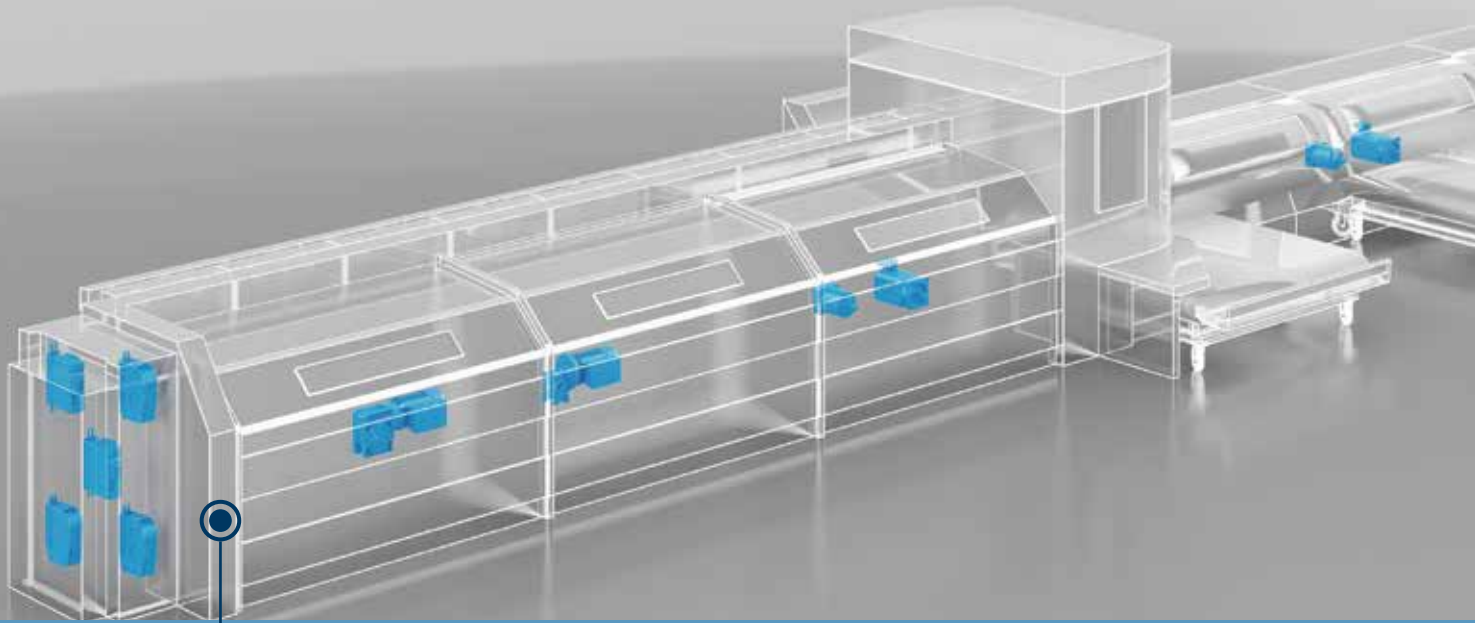

1 LASER TUBE CUTTING

2 METAL SHEET

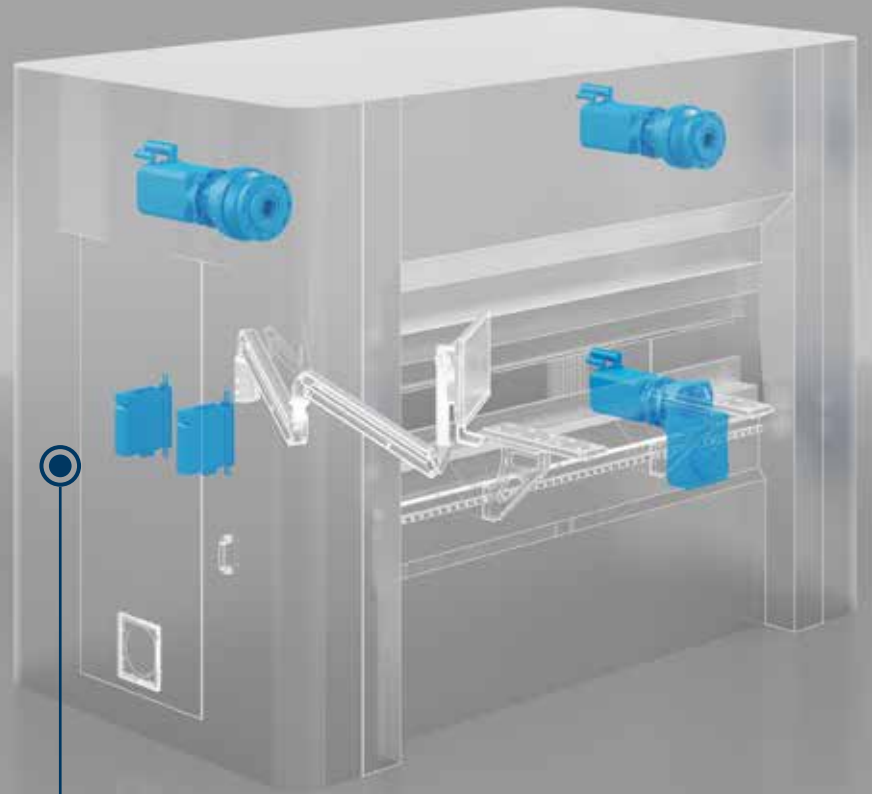

3 METAL SHEET BENDING

1

LASER TUBE CUTTING

Laser tube working machine, with suitable solutions for all axis. Our products are adaptable to existing design and easy to assemble, while saving space in the cabinet with our top class inverter power density.

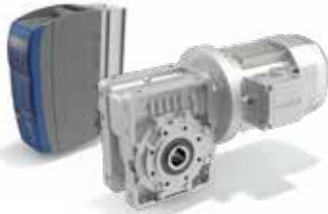
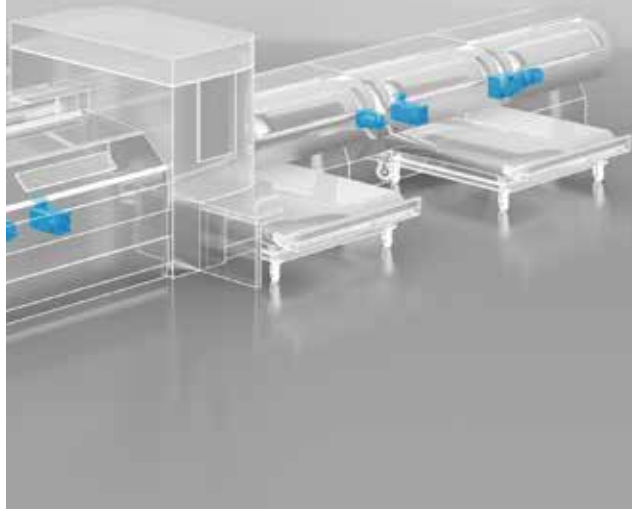

VF/W + IE3 + AGL

Open-loop inverter with worm gearmotor

- Suitable solutions for whole machine axis
- Easy-to-assembly and ready-to-go solutions
- Adaptable to existing design
- Space saving in cabinet

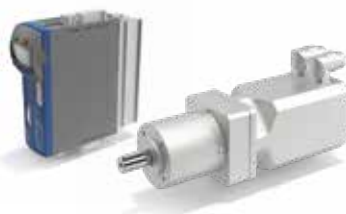

MP + BMD + ANG

Closed-loop inverter with precision servo gearmotor

- Suitable solutions for whole machine axis
- Easy-to-assembly and ready-to-go solutions
- Adaptable to existing design
- Space saving in cabinet



A + IE3 + AGL

Open-loop inverter with right-angle gearmotor

- Suitable solutions for whole machine axis
- Easy-to-assembly and ready-to-go solutions
- Adaptable to existing design
- Space saving in cabinet

BENEFITS

FEATURES

- One-Stop-Shop
- Flexible solutions thanks to wide product portfolio

- One-Stop-Shop
- Flexible solutions thanks to wide product portfolio
- Communication to any fieldbus
- Top class inverter power density

- One-Stop-Shop
- Flexible solutions thanks to wide product portfolio

2

METAL SHEET

Punching, shearing and bending are combined in the totally automatic and flexible production line, with no intermediate handling. Bonfiglioli combines performance and cost effectiveness through our selection tool and expertise.



A + BMD

Servo right-angle gearmotor

BENEFITS

- Suitable solutions for whole machine axis
- Optimized sizing via Bonfiglioli servo selection tool to combine performances and cost effectiveness
- High dynamics and compact solution

FEATURES

- One-Stop-Shop
- Bonfiglioli sector expertise at your disposal to co-design
- Servo-gearmotor based solutions



LC Series

Precision planetary gearbox

- Suitable solutions for whole machine axis
- Optimized sizing via Bonfiglioli servo selection tool to combine performances and cost effectiveness
- High dynamics and compact solution

- One-Stop-Shop
- Bonfiglioli sector expertise at your disposal to co-design



F + IE3

Parallel shaft gearmotor

- Suitable solutions for whole machine axis
- Optimized sizing via Bonfiglioli servo selection tool to combine performances and cost effectiveness
- High dynamics and compact solution

- One-Stop-Shop
- Bonfiglioli sector expertise at your disposal to co-design
- Servo-gearmotor based solutions

3**METAL SHEET BENDING**

The machine bends metal sheet with fully electric control. The Bonfiglioli solutions for the core axis are easy to refit, improving durability and requiring less maintenance compared to traditional solutions.

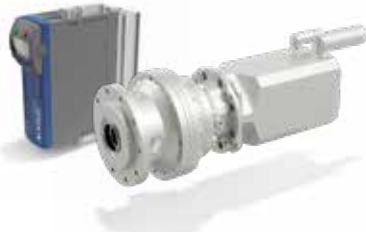
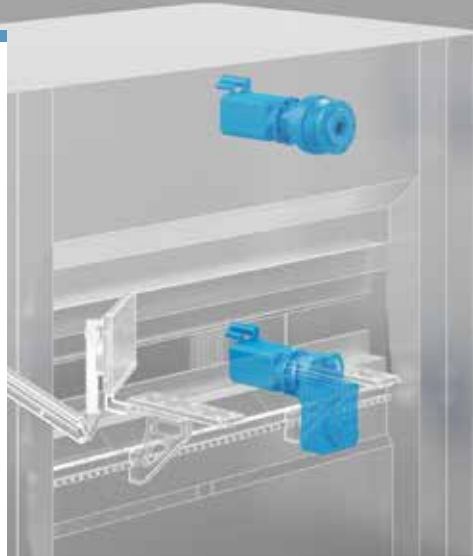
**300 + BMD + ACU**

Closed-loop inverter with synchronous reluctance motor and planetary gearbox

BENEFITS

- Enhanced durability, less maintenance compared to parallel shaft
- Servo performance motor without magnets
- Easy re-fitting
- No need for additional pulley, easier mounting

FEATURES

- Planetary gearbox solution for bending axis
- Synchronous Reluctance motor on bending axis
- Mechanically compatible with existing parallel shafts design

**F + BMD + ACU**

Closed-loop inverter with servo parallel shaft gearmotor

- Enhanced durability, less maintenance compared to parallel shaft
- Servo performance motor without magnets
- Easy re-fitting
- No need for additional pulley, easier mounting

- All-in-one gearbox design on croning axis



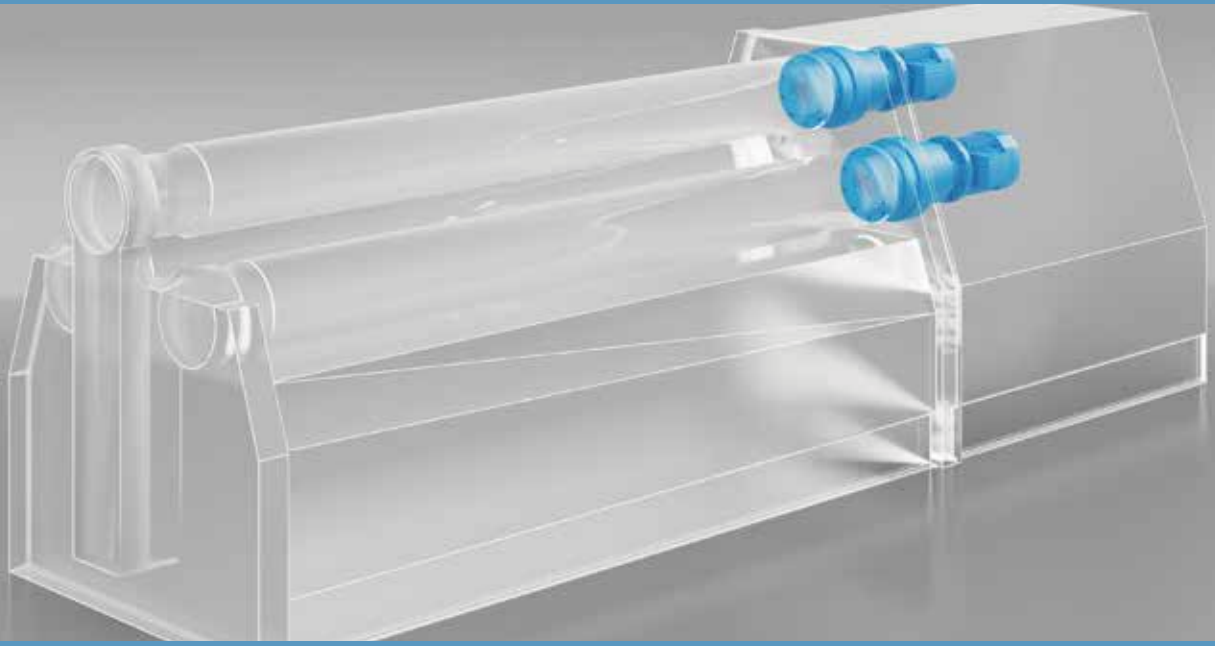

1

PLATE ROLL, PLATE BENDING

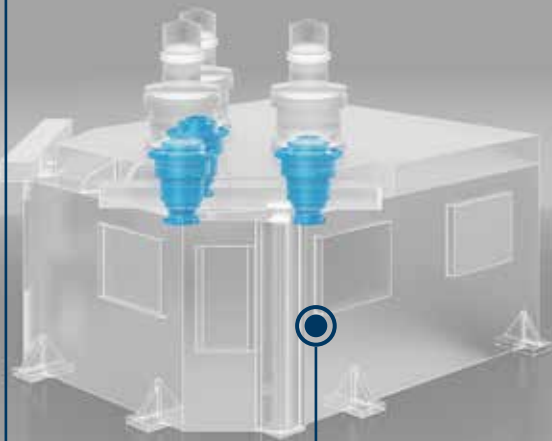

2

METAL PROFILE BENDING

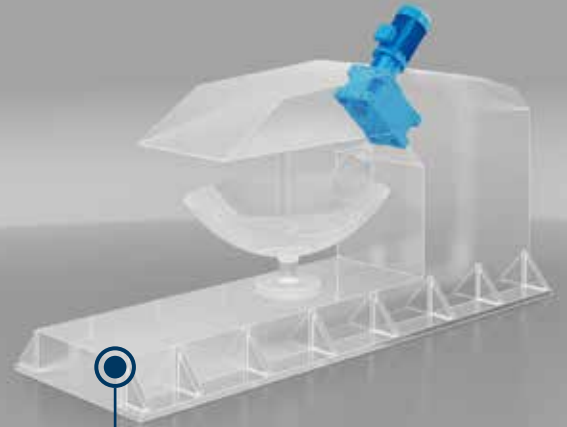

3

FLANGING MACHINES

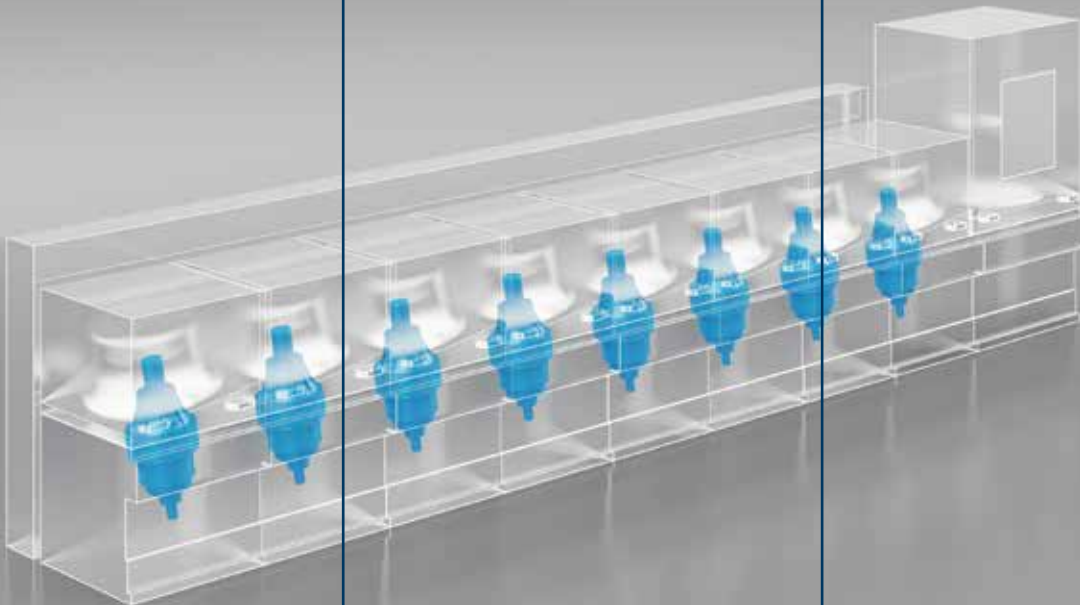
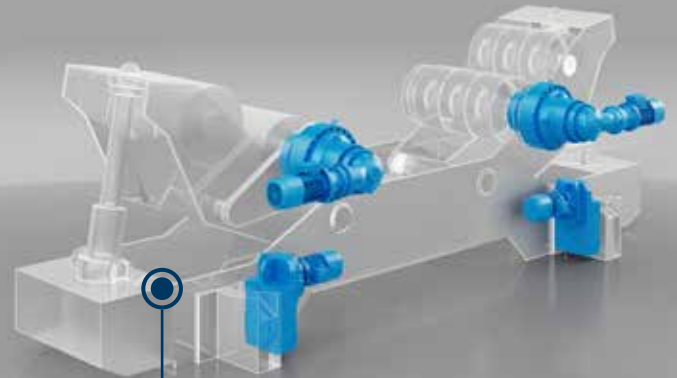
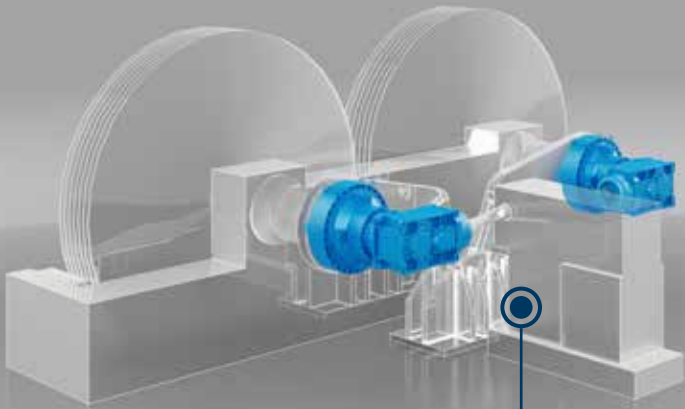

4 WIRE DRAWING MACHINE



5 PULLING CAPSTAN



**6 SELF-ALIGNING
ROLLER BEDS**

1**PLATE ROLL, PLATE BENDING**

A plate rolling machine is used to shape and form different kind of metal sheets with different thickness. The Gearmotors drive one or more pairs of rollers in order to obtain round or conical shapes through a calculated deformation process. Bonfiglioli supply a wide range of Planetary Hydraulic or Electric gearmotors with controls able to grant the highest level of performances to several different application segments.

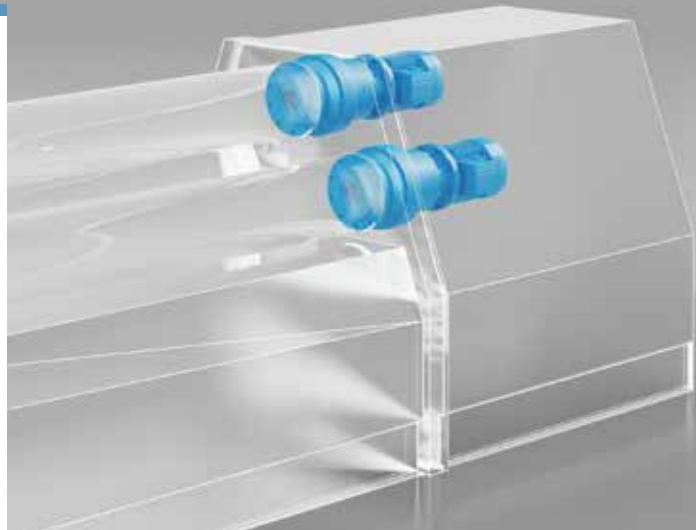

300 Series

Roller Drive

- Hydraulic or electric motor input solution
- High overload capacity
- Torque control
- Easy installation
- Brake available as an option



Active Cube Series

Premium Frequency Inverters

- Drive control highly customizable
- Great operational safety
- Higher productivity
- Increased service life of the crane
- Easy installation
- Lower total cost of ownership



BX Series

Asynchronous IE3 Three Phase Motor

- Motor efficiency class up to IE3
- Reliable, balanced and robust
- Complete solution (gear unit + Motor)
- Energy saving solution
- Compliant with the most of the efficiency standards

BENEFITS**FEATURES**

- Wide range of ratios
- Modular design
- In-line and right angle solutions
- Multiple output configurations and accessories
- Reinforced output shaft bearings
- Shock load up to 2.000.000 Nm

- Power Range: 0.37...1200 kW
- Open & closed loop field oriented control
- Master/Slave control and communication protocols
- PLC with integrated functionalities
- Coated boards
- STO Functional Safety
- Multi drive synchronisation and torque control
- Advanced brake control
- Brake chopper
- DC link connection for energy sharing
- Energy recovery braking (recovered electricity can be sent back to the grid)
- Energy consumption optimization (AEC/B)
- Mains unit (AEC/S)

- Power range: up to 355 kW
- Built in brakes available for all power/sizes
- Thermal protection: KTY, PTC, bimetal switches
- Forced ventilation
- Anti-condensate heaters
- Rotor balancing
- Second shaft extension
- Anti corrosive paintings up to C5M
- Tropicalization
- Degree of protection up to IP56

2

METAL PROFILE BENDING

Profile bending machines are used to shape tubes or profiles through a calculated deformation process into a form for several industrial purposes. The Bonfiglioli product portfolio satisfies the requirements coming from the different sizes or materials that can be processed in these machines. The drives can be equipped with hydraulic or electric motors with controls.

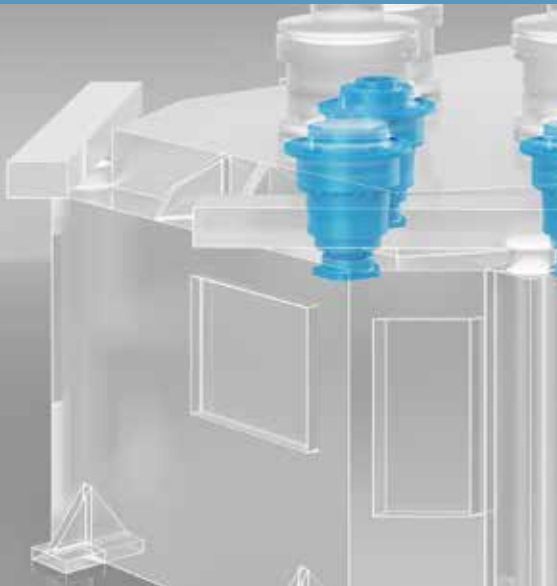

300 Series
Bending Drive



Active Cube Series
Premium Frequency
Inverters



BX Series
Asynchronous IE3
Three Phase Motor

BENEFITS

- Hydraulic or electric motor input solution
- High overload capacity
- Torque control
- Easy installation
- Brake available as an option

- Drive control highly customizable
- Great operational safety
- Higher productivity
- Increased service life of the crane
- Easy installation
- Lower total cost of ownership

- Motor efficiency class up to IE3
- Reliable, balanced and robust
- Complete solution (gear unit + Motor)
- Energy saving solution
- Compliant with the most of the efficiency standards

FEATURES

- Wide range of ratios
- Modular design
- In-line and right angle solutions
- Multiple output configurations and accessories
- Reinforced output shaft bearings
- Shock load up to 2.000.000 Nm

- Power Range: 0.37...1200 kW
- Open & closed loop field oriented control
- Master/Slave control and communication protocols
- PLC with integrated functionalities
- Coated boards
- STO Functional Safety
- Multi drive synchronisation and torque control
- Advanced brake control
- Brake chopper
- DC link connection for energy sharing
- Energy recovery braking (recovered electricity can be sent back to the grid)
- Energy consumption optimization (AEC/B)
- Mains unit (AEC/S)

- Power range: up to 355 kW
- Built in brakes available for all power/sizes
- Thermal protection: KTY, PTC, bimetal switches
- Forced ventilation
- Anti-condensate heaters
- Rotor balancing
- Second shaft extension
- Anti corrosive paintings up to C5M
- Tropicalization
- Degree of protection up to IP56

3**FLANGING MACHINES**

The Manufacturer process of dished and flanged heads for tanks and pressure vessels require high performances, in order to offer the maximum reliability to obtain tolerances and lamination reduction. Starting from circular plates of different thickness the machine press the plate with specific tools and repetitive actions in order to obtain the dished ends shape by cold forming. The final step is completing the dished ends by forming the edge for the circular welding. Bonfiglioli can provide the widest range of Power Transmissions and Mechatronics Solutions.



300 Series
Flanging Drive

BENEFITS

- Hydraulic or electric motor input solution
- High overload capacity
- Torque control
- Easy installation
- Brake available as an option

FEATURES

- Wide range of ratios
- Modular design
- In-line and right angle solutions
- Multiple output configurations and accessories
- Reinforced output shaft bearings
- Shock load up to 2.000.000 Nm



HDP Series
Flanging Drive

- High transmissible power
- Robustness
- Mounting flexibility
- Reliability

- Wide range of ratios
- Torque rating up to 210.000 Nm
- IEC or Nema motor flange
- Different output configurations and accessories

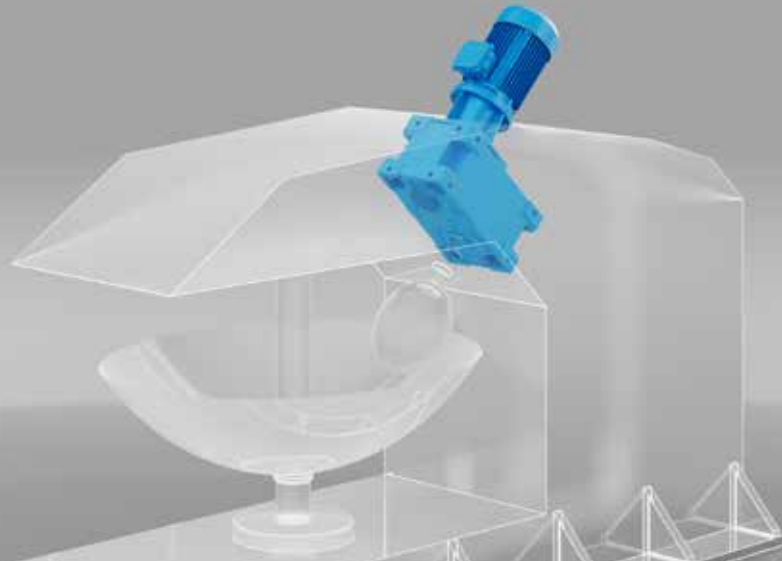

Active Cube Series

Premium Frequency Inverters

BENEFITS

- Drive control highly customizable
- Great operational safety
- Higher productivity
- Increased service life of the crane
- Easy installation
- Lower total cost of ownership

FEATURES

- Power Range: 0.37...1200 kW
- Open & closed loop field oriented control
- Master/Slave control and communication protocols
- PLC with integrated functionalities
- Coated boards
- STO Functional Safety
- Multi drive synchronisation and torque control
- Advanced brake control
- Brake chopper
- DC link connection for energy sharing
- Energy recovery braking (recovered electricity can be sent back to the grid)
- Energy consumption optimization (AEC/B)
- Mains unit (AEC/S)



BX Series

Asynchronous IE3 Three Phase Motor

- Motor efficiency class up to IE3
- Reliable, balanced and robust
- Complete solution (gear unit + Motor)
- Energy saving solution
- Compliant with the most of the efficiency standards

- Power range: up to 355 kW
- Built in brakes available for all power/sizes
- Thermal protection: KTY, PTC, bimetal switches
- Forced ventilation
- Anti-condensate heaters
- Rotor balancing
- Second shaft extension
- Anti corrosive paintings up to C5M
- Tropicalization
- Degree of protection up to IP56

4**WIRE DRAWING MACHINE**

Wire drawing is used for a metal working process that reduce the cross section of wire by pulling it through a series of dies. This process is a type of forging. Forging is the plastic, or permanent, changing of a metal shape and can be performed at hot, warm or cold temperatures. Bonfiglioli can provide the widest range of Planetary drives and alternative technologies of Power Transmissions and Controls.



300 Series
Drum Drive

BENEFITS

- Reinforced input shaft bearings
- Suitable for pulley and belt configuration
- High overload capacity
- Easy installation

FEATURES

- Wide range of ratios
- Modular design
- Parallel, In-line and right angle solutions
- Several output configurations



HDP Series
Drum Drive

- High transmissible power
- Robustness
- Mounting flexibility thanks to dedicated output flange
- Suitable for pulley and belt configuration
- Reliability

- Wide range of ratio
- Torque rating up to 210.000 Nm
- IEC or Nema motor flange



Active Cube Series

Premium Frequency Inverters

BENEFITS

- Drive control highly customizable
- Great operational safety
- Higher productivity
- Increased service life of the crane
- Easy installation
- Lower total cost of ownership

FEATURES

- Power Range: 0.37...1200 kW
- Open & closed loop field oriented control
- Master/Slave control and communication protocols
- PLC with integrated functionalities
- Coated boards
- STO Functional Safety
- Multi drive synchronisation and torque control
- Advanced brake control
- Brake chopper
- DC link connection for energy sharing
- Energy recovery braking (recovered electricity can be sent back to the grid)
- Energy consumption optimization (AEC/B)
- Mains unit (AEC/S)



BX Series

Asynchronous IE3 Three Phase Motor

- Motor efficiency class up to IE3
- Reliable, balanced and robust
- Complete solution (gear unit + Motor)
- Energy saving solution
- Compliant with the most of the efficiency standards

- Power range: up to 355 kW
- Built in brakes available for all power/sizes
- Thermal protection: KTY, PTC, bimetal switches
- Forced ventilation
- Anti-condensate heaters
- Rotor balancing
- Second shaft extension
- Anti corrosive paintings up to C5M
- Tropicalization
- Degree of protection up to IP56

5

PULLING CAPSTAN

Pulling capstan with belt or double capstan for extrusion lines or stranding to perform wide range for all types of cables.

Bonfiglioli supply a wide range of combined gear unit Helical Bevel Planetary for different machine capacity.

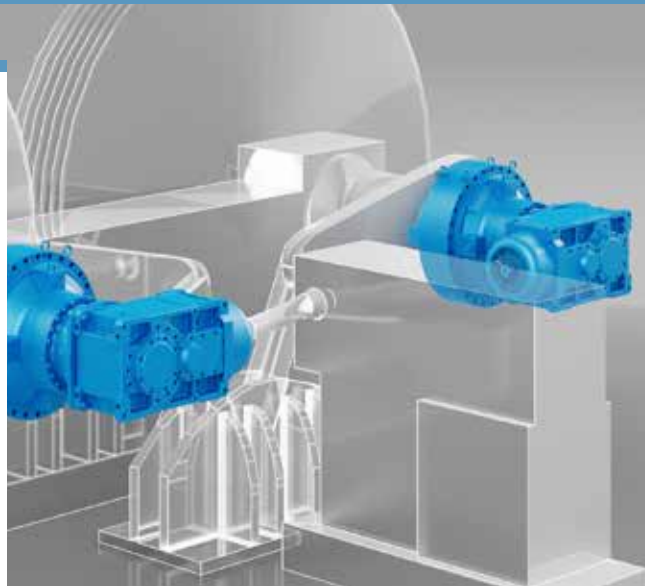

3/H Series

Pulling Capstan Drive

- Extremely high transmissible torque and power
- Suitable for all heavy-duty applications
- High shock resistance
- Reliability
- Easy maintenance
- High level of customization



Active Cube Series

Premium Frequency Inverters

- Drive control highly customizable
- Great operational safety
- Higher productivity
- Increased service life of the crane
- Easy installation
- Lower total cost of ownership



BX HD Series

Asynchronous IE3 Three Phase motor

- Robustness
- Long lifetime
- Wide power range
- Energy saving
- Compliant to all the MEPS
- Complete solution (gear unit + motor)
- Control flexibility
- Global motor that can be used in most of the markets

BENEFITS

FEATURES

- Increased bearing load capability
- Nominal torque up to 1,300,000 Nm
- Modular design

- Power Range: 0.37...1200 kW
- Open & closed loop field oriented control
- Master/Slave control and communication protocols
- PLC with integrated functionalities
- Coated boards
- STO Functional Safety
- Multi drive synchronisation and torque control
- Advanced brake control
- Brake chopper
- DC link connection for energy sharing
- Energy recovery braking (recovered electricity can be sent back to the grid)
- Energy consumption optimization (AEC/B)
- Mains unit (AEC/S)

- Standard IP55 also for brakemotors
- Cast iron housing
- Inverter duty ready
- SPM measurement
- Certified motor (DOE, NRCAN, CCC...)



6**SELF-ALIGNING ROLLER BEDS**

Self-aligning roller beds is used in the Heavy Duty industry for positioning and rotating huge cylindrical structures in order to execute multiple final operations. The rotation of the structures is driven by AC geared motors at variable speed. Machine can be fixed to the floor or rails mounted in order to increase the efficiency of the equipment. Bonfiglioli supply a wide range of Planetary, Helical parallel and Helical Bevel gearmotors and controls providing the highest level of performances for different machine capacity and the worst ambient condition.



300 Series
Self Roller Drive

BENEFITS

- Robustness
- High torque density
- High overload capacity
- High overhung load capacity
- Easy fit

FEATURES

- Wide range of ratios
- Modular design
- Parallel, In-line and Right angle solutions
- Multiple output configurations and accessories
- Explosion proof certification



A Series
Self Roller Drive

- High efficiency
- Reliability and robustness
- Compactness
- Low maintenance
- Space effective & compactness with right angle arrangement

- Power range: up to 55 kW
- Shaft mounted solution with different output configurations
- Torque arm and anti-vibration kits
- Wide range of ratios
- Space-saving compact motor design
- Compact or IEC/NEMA Flanged motor adaptors



F Series
Self Roller Drive

- High efficiency
- Reliability and robustness
- Compactness
- Low maintenance

- Parallel shafts design
- Power range: up to 55 kW
- Shaft mounted solution with different output configurations
- Housing integrated torque arm design and anti-vibration kits
- Wide range of ratios
- Space-saving compact motor design
- Fluor Elastomer Seals

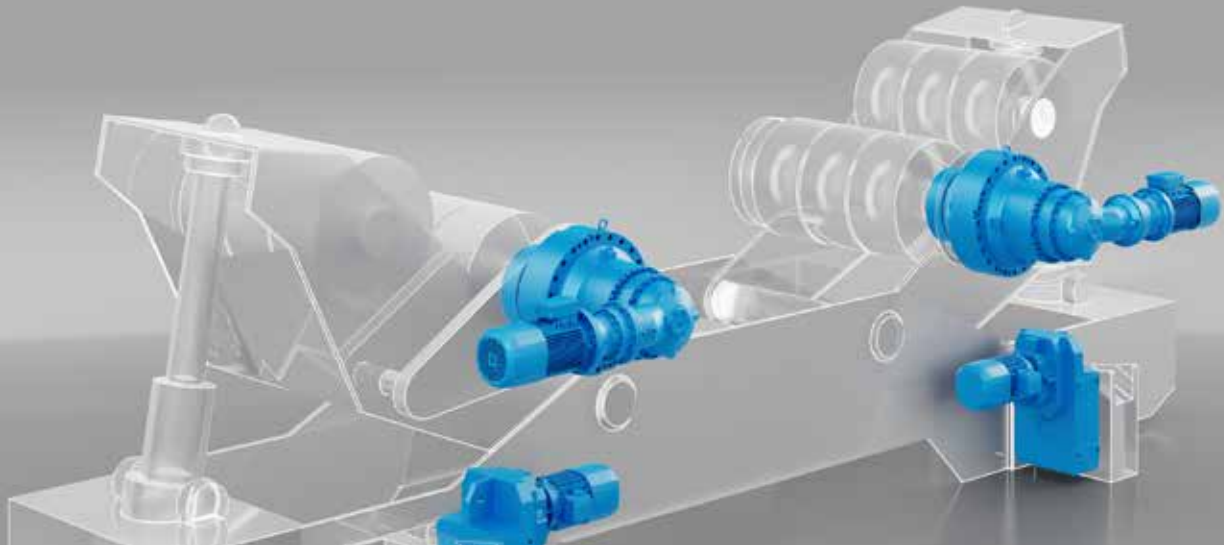

Active Cube Series

Premium Frequency Inverters

BENEFITS

- Drive control highly customizable
- Great operational safety
- Higher productivity
- Increased service life of the crane
- Easy installation
- Lower total cost of ownership

FEATURES

- Power Range: 0.37...1200 kW
- Open & closed loop field oriented control
- Master/Slave control and communication protocols
- PLC with integrated functionalities
- Coated boards
- STO Functional Safety
- Multi drive synchronisation and torque control
- Advanced brake control
- Brake chopper
- DC link connection for energy sharing
- Energy recovery braking (recovered electricity can be sent back to the grid)
- Energy consumption optimization (AEC/B)
- Mains unit (AEC/S)



BX Series

Asynchronous IE3 Three Phase Motor

- Motor efficiency class up to IE3
- Reliable, balanced and robust
- Complete solution (gear unit + Motor)
- Energy saving solution
- Compliant with the most of the efficiency standards

- Power range: up to 355 kW
- Built in brakes available for all power/sizes
- Thermal protection: KTY, PTC, bimetal switches
- Forced ventilation
- Anti-condensate heaters
- Rotor balancing
- Second shaft extension
- Anti corrosive paintings up to C5M
- Tropicalization
- Degree of protection up to IP56

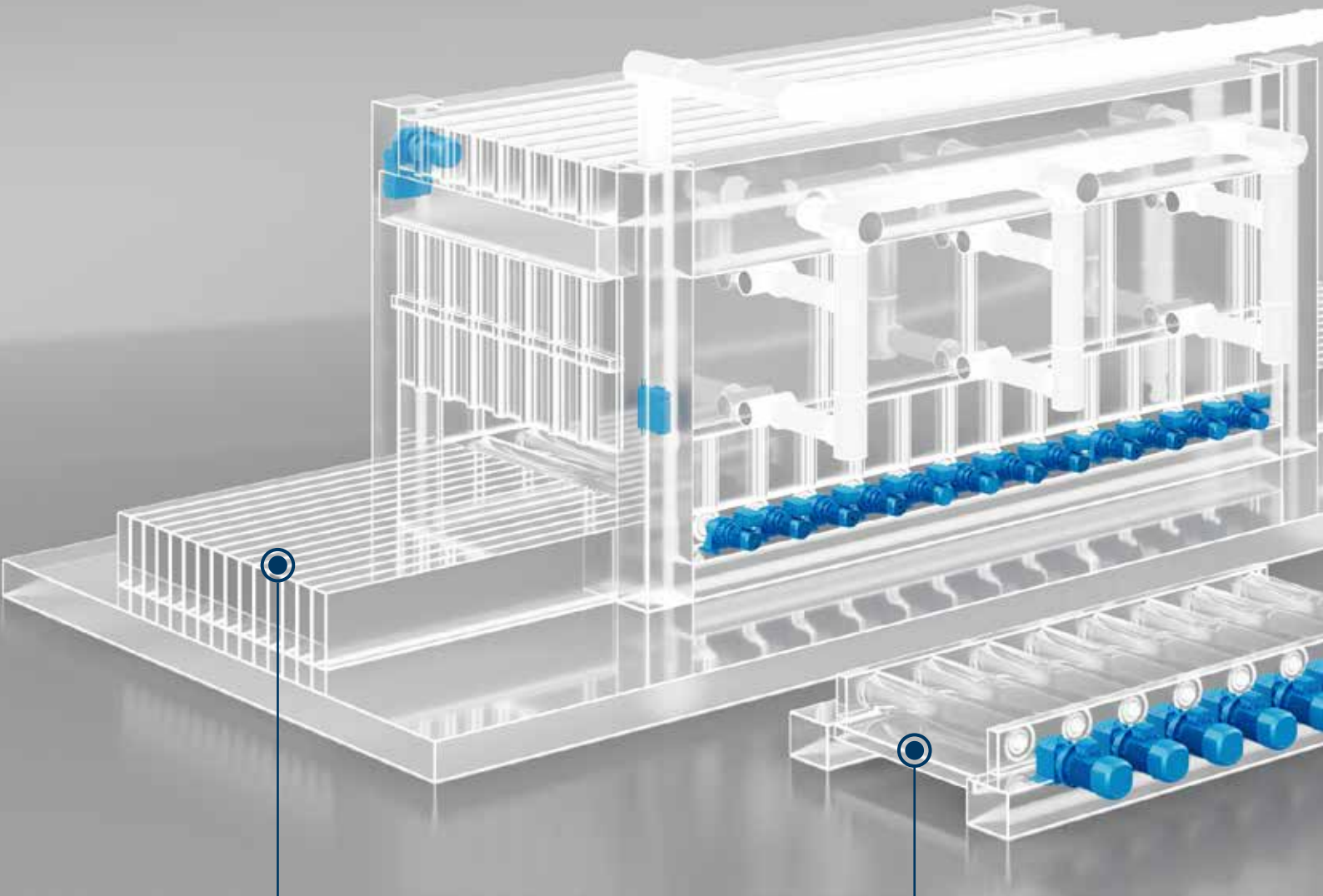

1 FURNACE



2 ROLLER TABLE

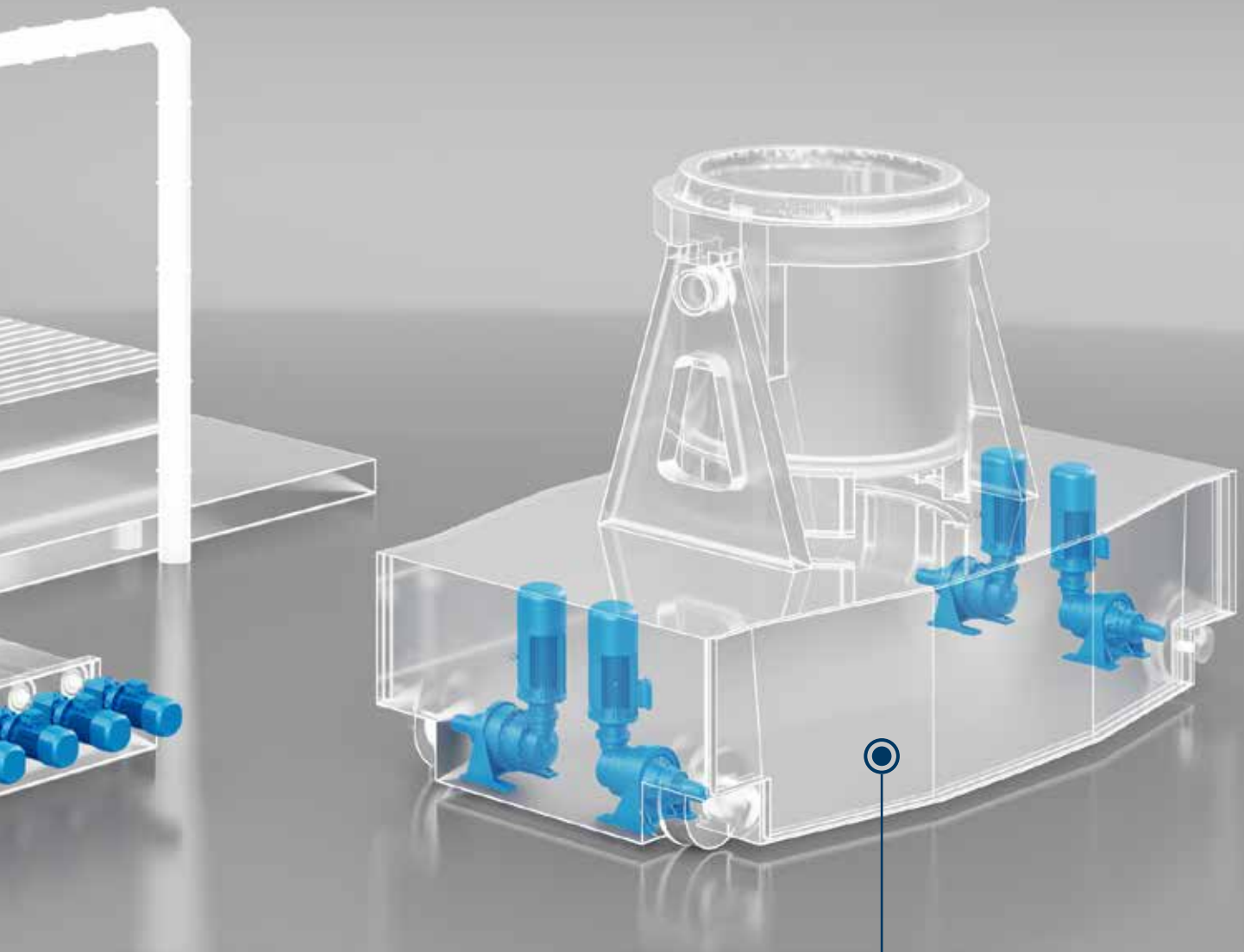

3 LADLE TRANSFER CAR

1**FURNACE**

The heating process is performed by different types of furnaces. Reheating furnaces, heat treatment furnaces and furnaces for hot rolling mills (Billets, blooms or slabs) require solutions for roller table conveyor and door movement. All these applications requires solutions designed for harsh and wide range ambient temperature condition. Bonfiglioli 300M series allows flexibility to combine dedicated input and output shaft for roller table conveyors. When coupled to our IE4 BSR synchronous reluctance motors forced ventilation is not required at low operating speed and you can experience an accurate speed and torque control also in open loop when you combine it with our ACU drives. Our solutions are the best in class in terms of MTBF (meantime before failure) and suit the needs of continuous running applications. In addition, we can improve the reliability and minimize the unplanned downtimes thanks to our condition monitoring made with our own IOT platform and sensors.

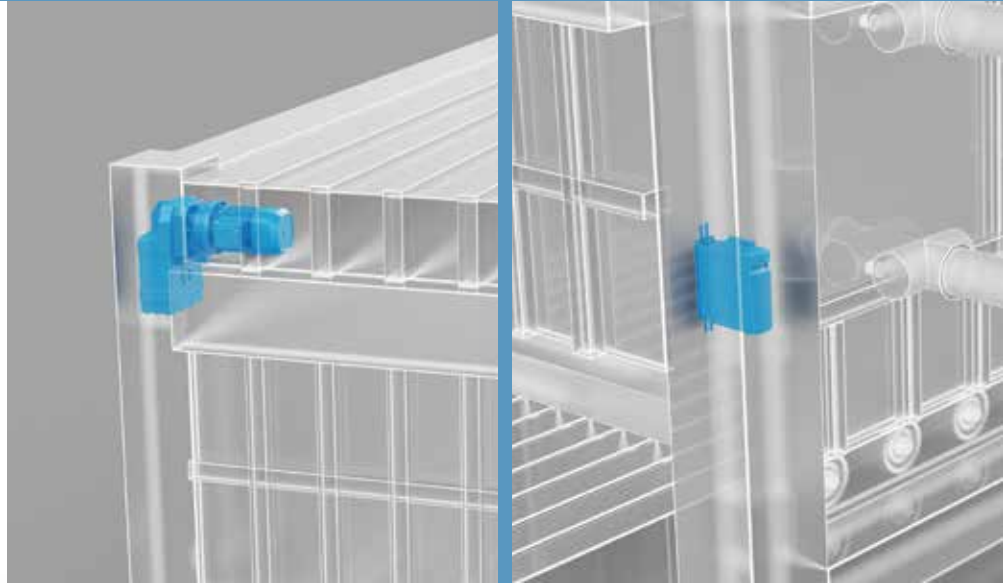

F & A Series + BX Series + Active Cube Series Furnace Door Drive

BENEFITS

- Low maintenance
- Easy installation
- Space effective
- IES2 power drive system solution

FEATURES

- Torque arm and anti-vibration kits
- Space-saving compact gearmotor design
- Compact or IEC/NEMA gearbox flange adapters
- Fluor Elastomer Seals
- Wide power range: up to 55 kW
- IE3 energy efficiency level
- Worldwide certification
- Wide range of temperature sensors
- Independent servo fan option
- Ready for heavy duty applications



300M Series + BSR Series + DGM-MPM Series

Roller Drive

BENEFITS

- Low maintenance
- Compactness
- Energy saving solution
- Reliability and robustness
- Low wiring costs
- IES2 power drive system solution

FEATURES

- Made in spheroidal cast iron
- Modular design (input, output, mounting)
- Peak torque up to 2.000.000 Nm
- Space-saving compact gearmotor design
- High overload capacity
- Fluor elastomer seals
- Energy efficiency up to IE4 and UL certification
- High efficiency solution up to 9,2kW (size 132)
- High output configuration up to 18,5kW (size 132)
- Open loop sensorless control mode
- Motor or wall mounting solution

2**ROLLER TABLE**

A roller table is a fundamental equipment used inside several production plants to transport the material along the different process stations. These rollers are commonly driven by electrical gearmotors which can be directly connected to the roller shaft: one gearmotor for every single roller, or one gearmotor that can drive more than one roller thanks to gears and chains.

Output speed can vary according to the process phase or to the material weight. Heavier material will have lower speed, so a wide range of motor speed is fundamental. Bonfiglioli can offer the widest product portfolio along with the most optimized solutions for drives and controls with a wide range of speed adjustment according to material handling weight and specs. All metal working related applications requires solutions designed for harsh and wide range ambient temperature condition. Our solution allows flexibility to combine dedicated input and output shaft for roller table conveyors.

Our solutions are the best in class in terms of MTBF (meantime before failure) and suit the needs of continuous running applications.

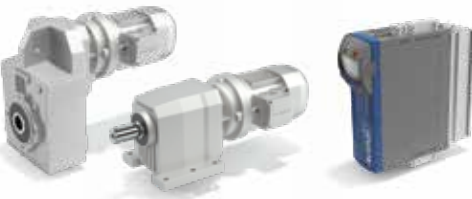
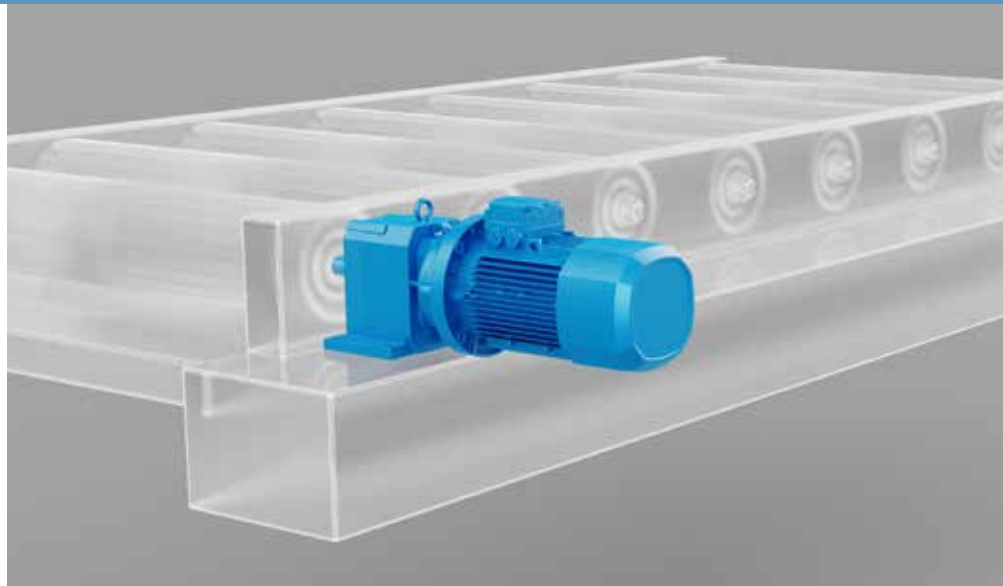

F & C Series + BX Series + Active Cube Series

Roller Drive

BENEFITS

- Low maintenance
- Easy installation
- Space effective
- IES2 power drive system solution

FEATURES

- Torque arm and anti-vibration kits
- Space-saving compact gearmotor design
- Compact or IEC/NEMA gearbox flange adapters
- Fluor Elastomer Seals
- Wide power range: up to 55 kW
- IE3 Worldwide certification
- Wide range of temperature sensors
- Independent servo fan option
- Ready for heavy duty applications



3

LADLE TRANSFER CAR

A ladle transfer car is used in foundries and metallurgy industry to transport the molten metals. Ladle cars can have different shapes and capacities. Thanks to the wide product portfolio, Bonfiglioli can provide the best fitting solution according to the machine design and capable to withstand harsh and wide range ambient temperature condition.

Thanks to our solution and experience we have the flexibility to combine dedicated input and output shaft according to the tightest installation space typical of Ladle transfer car application. We are able to provide our customers of a very compact solution with heavy duty design lifetime criteria as well as a cost saving offer that allow to drive 2 gearmotors with only one inverter. The smooth payload handling is assured thanks to controllable s-ramp and anti sloshing dedicated functions.

Our solutions are the best in class in terms of MTBF (meantime before failure) and suit the needs of continuous running applications.

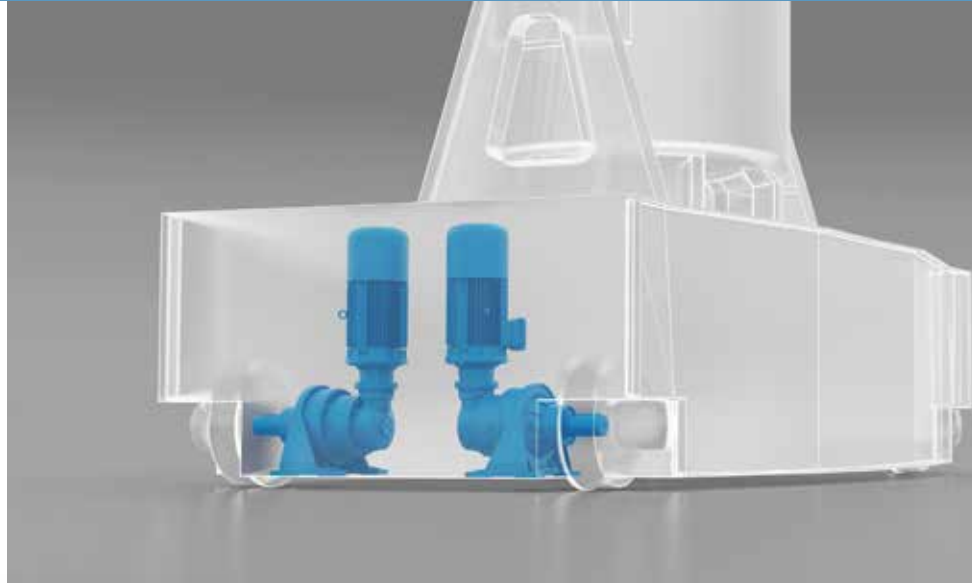

F Series + BX Series + Active Cube Series

Wheel Drive

BENEFITS

- Low maintenance
- Easy installation
- Space effective
- IES2 power drive system solution

FEATURES

- Torque arm and anti-vibration kits
- Space-saving compact gearmotor design
- Fluor Elastomer Seals
- Wide power range: up to 55 kW
- IE3 Worldwide certification
- Wide range of temperature sensors
- Independent servo fan option
- Ready for heavy duty applications

300M Series + BX Series + Active Cube Series

Wheel Drive

- Low maintenance
- Compactness
- Energy saving solution
- Reliability and robustness
- IES2 power drive system solution

- Made in spheroidal cast iron
- Modular design (input, output, mounting)
- Peak torque up to 2.000.000 Nm
- Space-saving compact gearmotor design
- High overload capacity
- Wide power range: up to 55 kW
- IE3 Worldwide certification
- Wide range of temperature sensors
- Motor winding insulation class up to CLH
- Independent servo fan option
- Ready for heavy duty applications

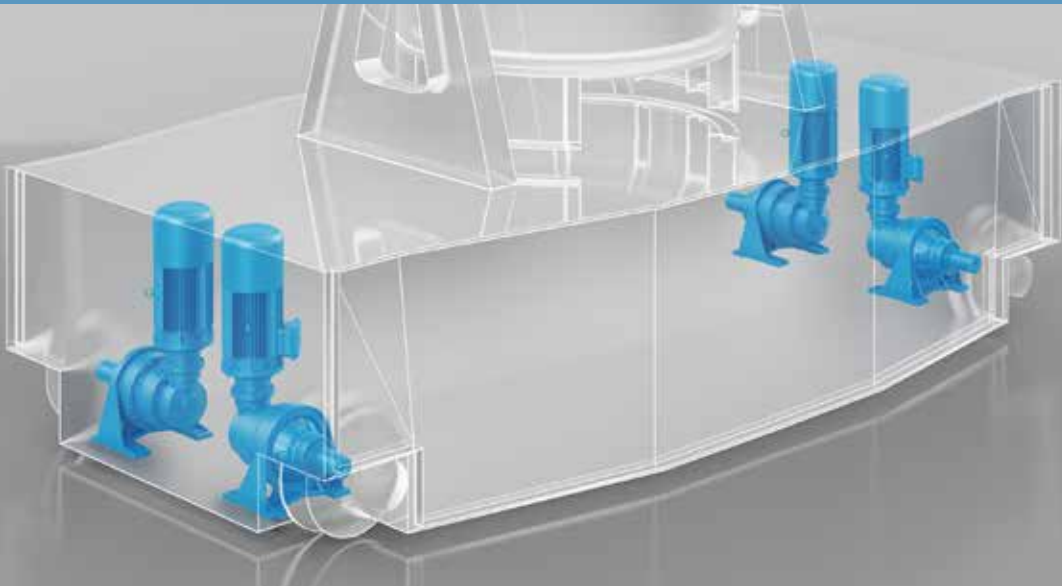

HDx Series + BX Series + Active Cube Series

Wheel Drive

BENEFITS

- Low maintenance
- Easy installation
- Energy saving solution
- Reliability and robustness
- IES2 power drive system solution

FEATURES

- Different output shaft accessories
- Squared gearbox frame
- Torque arm and anti-vibration kits
- Torque rating up to 210.000Nm
- Fluor Elastomer Seals
- Many cooling device available
- Wide power range: up to 55 kW
- IE3 Worldwide certification
- Wide range of temperature sensors
- Independent servo fan option
- Ready for heavy duty applications.

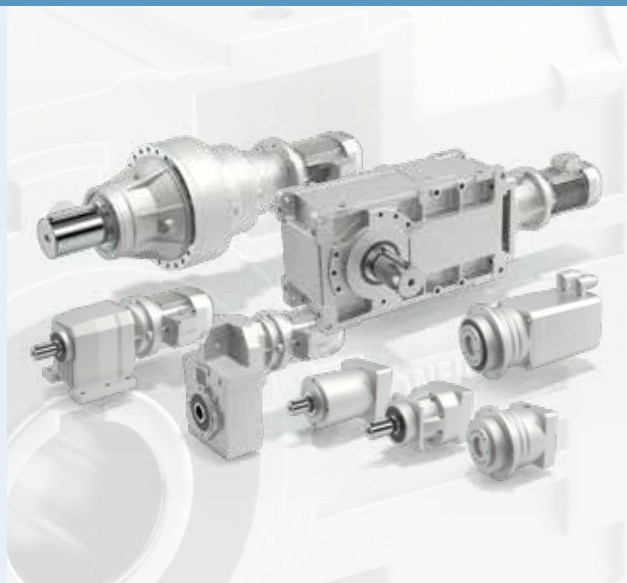

GEARBOXES & GEARED MOTORS

HEAVY DUTY

Heavy duty parallel/right angle shaft geared motors HDP/HDO Series

- Torque range: 5,190 to 210,000 Nm
- Gear ratios: 5.6 to 500

Planetary geared motors | 300 Series

- Torque range: 1,250 to 1,287,000 Nm
- Gear ratios: 3.4 ... 2,916

LIGHT DUTY

Worm geared motors | W/VF Series

- Torque range: 13 to 7,100 Nm
- Gear ratios: 5.6 to 500

Helical geared motors | C Series

- Torque range: 45 to 12,000 Nm
- Gear ratios: 5.6 to 500

Bevel-helical geared motors | A Series

- Torque range: 100 to 14,000 Nm
- Gear ratios: 5.6 to 500

Shaft-mounted geared motors | F Series

- Torque range: 140 to 14,000 Nm
- Gear ratios: 5.6 to 500

SERVO

Precision planetary servo geared motors

TQ, TQK, TQF, TR, MP, LC, LCK, SL, KR Series

- Torque range: up to 1,000 Nm
- Gear ratios: up to 1,000
- Backlash: lower than 2 and 17 arcmin

MOTORS

Asynchronous IEC motors | BN, BE, BX Series

Asynchronous compact motors | MN, ME, MX series

A complete range of AC motors, meeting worldwide MEPS (e.g. IE3)

- Power range: 0.06 to 355 kW
- Poles: from 2 to 8 and multiple poles

IE3

Asynchronous motors | BN, BE, BX, M, ME, MX Series

A complete range of AC motors, meeting worldwide MEPS (e.g. IE3)

- Power range: 0.06 to 355 kW
- Poles: from 2 to 8 and multiple poles

IE3

Synchronous motors | BMD Series

- Stall torque: 0.85 to 60 Nm
- Rated speed: from 1,600 to 6,000 min⁻¹
- Power supply: 230, 400 VAC

Synchronous reluctance motors | BSR Series

Two different versions for different needs: High efficiency IE4 and high output

- Power range: 0.37 to 18.5 kW

IE4

Synchronous motors | BMD, BCR Series

- Stall torque BMD: 0.85 to 60 Nm
- Stall torque BCR: 0.2 to 115 Nm
- Rated speed BMD: from 1,600 to 6,000 min⁻¹
- Rated speed BCR: from 2,000 to 4,500 min⁻¹
- Power supply: 230, 400 VAC

Synchronous motors with integrated drives | iBMD Series

- Stall torque: 2.7 to 36 Nm
- Rated speed: 3,000 min⁻¹
- Power supply: 560 VDC



CABINET INVERTERS

HEAVY DUTY

Cabinet solution | Active Cube 8 IP54

- Power range: 200 up to 1,200 kW
- Voltage: 400 V, 525V, 690V

Premium inverter | Active Cube Series

- ACU210: 0.25 - 9.2 kW / 1- or 3-phase
- ACU410*: 0.25 - 400 kW / 3-phase
- ACU510*: 160 - 400 kW / 3-phase
- ACU610*: 0.25 - 400 kW / 3-phase

LIGHT DUTY

Premium inverter | Active Cube Series

- ACU210: 0.25 - 9.2 kW / 1- or 3-phase
- ACU410*: 0.25 - 400 kW / 3-phase
- ACU510*: 160 - 400 kW / 3-phase
- ACU610*: 0.25 - 400 kW / 3-phase

Smart inverter | Agile Series

- AGL202: 0.12 - 3 kW / 1-phase | 0.25 - 7.5 kW / 3-phase
- AGL402: 0.25 - 11 kW / 3-phase

Compact inverter | S2U Series

- S2U230S---(F) IP66: 0.25 - 400 kW / 3-phase

SERVO

Servo inverter | ANG Series

- ANG210: 0.25 - 9.2 kW / 1- or 3-phase
- ANG410*: 0.25 - 400 kW / 3-phase
- ACU510*: 160 - 400 kW / 3-phase
- ANG610*: 0.25 - 400 kW / 3-phase

Premium inverter | Active Cube Series

- ACU210: 0.25 - 9.2 kW / 1- or 3-phase
- ACU410*: 0.25 - 400 kW / 3-phase
- ACU510*: 160 - 400 kW / 3-phase
- ACU610*: 0.25 - 400 kW / 3-phase

Smart inverter | Agile Series

- AGL202: 0.12 - 3 kW / 1-phase | 0.25 - 7.5 kW / 3-phase
- AGL402: 0.25 - 11 kW / 3-phase

* up to 1200 kW with parallel connection

DECENTRALIZED INVERTERS

DGM1

- Size A: 0.37 - 1.1 kW / 1-phase
- Voltage: 230 V
- Motor type: Asynchronous

DGM3

- Size A: 0.55 - 1.5 kW / 3-phase
- Size B: 2.2 - 4 kW / 3-phase
- Size C: 5.5 - 7.5 Kw / 3-phase
- Size D: 11 - 22 kW / 3-phase
- Voltage: 3 x 200 Vac -10%... 480 Vac +10%
280 Vdc -10%... 680 Vdc +10%
- Motor type: Asynchronous

DGM MPM

- Size A: 0.55 - 1.5 kW / 3-phase
- Size B: 2.2 - 4 kW / 3-phase
- Size C: 5.5 - 7.5 Kw / 3-phase
- Size D: 11 - 30 kW / 3-phase
- Voltage: 3 x 200 Vac -10%... 480 Vac +10%
280 Vdc -10%... 680 Vdc +10%
- Motor type: Asynchronous & Synchronous

OUR GLOBAL PRESENCE

Thanks to an international network of closely interconnected commercial and production sites, we can guarantee the same high standards of Bonfiglioli quality anywhere at any given time. We know that our direct presence in local markets is the key to long-lasting success, so our family includes 20 production sites, 26 commercial sites and more than 550 distributors around the world.

Our organization is always close by, offering complete and efficient solutions and supporting our customers with dedicated services, co-engineering and after-sales assistance.



20
PRODUCTION SITES

26
COMMERCIAL SITES

80
COUNTRIES

550
DISTRIBUTORS

~4,800
PEOPLE

AUSTRALIA

Bonfiglioli Transmission (Aust.) Pty Ltd
2, Cox Place Glendenning NSW 2761
Locked Bag 1000 Plumpton NSW 2761
Tel. +61 2 8811 8000



BRAZIL

Bonfiglioli Redutores do Brasil Ltda
Av. Osvaldo Fregonezi, 171, cjs 31 e 44
CEP 09851-015 - São Bernardo do Campo
São Paulo
Tel. +55 11 4344 2322



CHINA

Bonfiglioli Drives (Shanghai) Co. Ltd.
#68, Hui-Lian Road, QingPu District,
201707 Shanghai
Tel. +86 21 6700 2000



Motion & Robotics

#568, Longpan Road, Jiading District,
201707 Shanghai



Bonfiglioli Trading (Shanghai) Co. Ltd.
Room 423, 4th Floor, #38, Yinglun Road,
China (Shanghai) Pilot Free Trade Zone,
Shanghai



Selcom Electronics (Shanghai) Co., Ltd
A7, No.5399, Waiqingsong Road, QingPu
District,
201707 Shanghai
Tel. +86 21 6010 8100



A24, No.5399, Waiqingsong Road, QingPu
District,
201707 Shanghai
Tel. +86 21 6010 8100



FRANCE

Bonfiglioli Transmission S.A.S.
14 Rue Eugène Pottier
Zone Industrielle de Moimont II
95670 Marly la Ville
Tel. +33 1 34474510



GERMANY

Bonfiglioli Deutschland GmbH
Sperberweg 12 - 41468 Neuss
Tel. +49 0 2131 2988 0



Bonfiglioli Vectron GmbH
Europark Fichtenhain B6 - 47807 Krefeld
Tel. +49 0 2151 8396 0



O&K Antriebstechnik GmbH
Ruhrallee 8-12 - 45525 Hattingen
Tel. +49 0 2324 2050 1



INDIA

Bonfiglioli Transmission Pvt. Ltd.
Mobility & Wind Industries
AC 7 - AC 11 Sidco Industrial Estate
Thirumudivakkam Chennai - 600 044
Tel. +91 844 844 8649



**Discrete Manufacturing &
Process Industries - Motion & Robotics**
Survey No. 528/1,
Perambakkam High Road Mannur Village,
Sriperumbudur Taluk Chennai - 602 105
Tel. +91 844 844 8649



**Discrete Manufacturing &
Process Industries**

Plot No.A-9/5, Phase IV MIDC Chakan,
Village Nighoje Pune - 410 501
Tel. +91 844 844 8649



ITALY

Bonfiglioli Riduttori S.p.A.
**Discrete Manufacturing &
Process Industries**
Via Cav. Clementino Bonfiglioli, 1
40012 Calderara di Reno
Tel. +39 051 6473111



**Discrete Manufacturing &
Process Industries**

Via Sandro Pertini, lotto 7b
20080 Carpiano
Tel. +39 02985081



**Discrete Manufacturing &
Process Industries**

Via Saliceto, 15 - 40010 Bentivoglio



Mobility & Wind Industries

Via Enrico Mattei, 12 Z.I. Villa Selva
47122 Forlì
Tel. +39 0543 789111



Motion & Robotics

Via Unione, 49 - 38068 Rovereto
Tel. +39 0464 443435/36



Selcom Group S.p.A.

Via Achille Grandi, 5
40013 Castel Maggiore (BO)
Tel. +39 051 6387111



Via Marino Serenari, 18
40013 Castel Maggiore (BO)
Tel. +39 051 6387111



Via Cadriano, 19
40057 Cadriano (BO)
Tel. +39 051 6387111



NEW ZEALAND

Bonfiglioli Transmission (Aust.) Pty Ltd
88 Hastie Avenue, Mangere Bridge,
2022 Auckland
PO Box 11795, Ellerslie
Tel. +64 09 634 6441



SINGAPORE

Bonfiglioli South East Asia Pte Ltd
8 Boon Lay Way, #04-09,
8@Tadehub 21, Singapore 609964
Tel. +65 6268 9869



SLOVAKIA

Bonfiglioli Slovakia s.r.o.
Robotnícka 2129
Považská Bystrica, 01701 Slovakia
Tel. +421 42 430 75 64



SOUTH AFRICA

Bonfiglioli South Africa Pty Ltd.
55 Galaxy Avenue, Linbro Business Park,
Sandton, Johannesburg
2090 South Africa
Tel. +27 11 608 2030



SPAIN

Tecnotrans Bonfiglioli S.A
Avinguda del Ferrocarril, nº 14,
Polígono Industrial Can Estapé
08755 Castellbisbal - Barcelona
Tel. +34 93 447 84 00



TURKEY

Bonfiglioli Turkey Jsc
Atatürk Organize Sanayi Bölgesi,
10007 Sk. No. 30
Atatürk Organize Sanayi Bölgesi,
35620 Çiğli - İzmir
Tel. +90 0 232 328 22 77



UNITED KINGDOM

Bonfiglioli UK Ltd.
Unit 1 Calver Quay, Calver Road, Winwick
Warrington, Cheshire - WA2 8UD
Tel. +44 1925 852667



USA

Bonfiglioli USA Inc.
3541 Hargrave Drive
Hebron, Kentucky 41048
Tel. +1 859 334 3333



VIETNAM

Bonfiglioli Vietnam Ltd.
Lot C-9D-CN My Phuoc Industrial Park 3
Ben Cat - Binh Duong Province
Tel. +84 650 3577411





We have a relentless commitment to excellence, innovation & sustainability. Our team creates, distributes and services world-class power transmission & drive solutions to keep the world in motion.

HEADQUARTERS

Bonfiglioli S.p.A

Via Cav. Clementino Bonfiglioli, 1
40012 Calderara di Reno - Bologna (Italy)
Tel. +39 051 6473111

